

## Table of Contents

<b>1. Your new Eagle 599</b>	<b>2</b>
<b>1.1. Unpacking Eagle 599</b>	<b>2</b>
<b>1.2. About this Manual</b>	<b>2</b>
<b>1.3. Accessory package</b>	<b>2</b>
<b>1.4. Connection to Antenna &amp; Power Supply</b>	<b>3</b>
<b>1.5. A word about grounding</b>	<b>3</b>
<b>1.6. Philosophy of design</b>	<b>4</b>
<b>1.7. Configuration Menu</b>	<b>5</b>
<b>2. Easy Operation Guide</b>	<b>6</b>
<b>2.1. General Operations</b>	<b>6</b>
<b>2.2. SSB Mode Operation</b>	<b>13</b>
<b>2.3. CW Mode Operation</b>	<b>17</b>
<b>2.4. AM Mode Operation</b>	<b>18</b>
<b>2.5. FM Mode Operation</b>	<b>18</b>
<b>2.6. Mobile Operation</b>	<b>18</b>
<b>2.7. Digital Mode Operation</b>	<b>18</b>
<b>2.8. Internal Hardware Noise Blanker</b>	<b>18</b>
<b>2.9. Internal Tuner</b>	<b>18</b>
<b>2.10. Optional Filter Installation</b>	<b>19</b>
<b>Eagle Rear Panel</b>	<b>20</b>
<b>4. Accessory Devices</b>	<b>22</b>
<b>4.1. Using the 712 USB/Soundcard Interface</b>	<b>22</b>
<b>4.2. Interfacing to a computer and firmware updates</b>	<b>22</b>
<b>4.3. List of Optional Accessories For The Eagle</b>	<b>24</b>
<b>5. Specifications</b>	<b>25</b>
<b>5.1. Transceiver Specifications</b>	<b>25</b>
<b>5.2. Transceiver Block Diagram</b>	<b>28</b>
<b>6. In Case of Difficulty</b>	<b>30</b>
<b>7. Warranty &amp; Return Policy</b>	<b>32</b>
<b>8. Revision History</b>	<b>32</b>

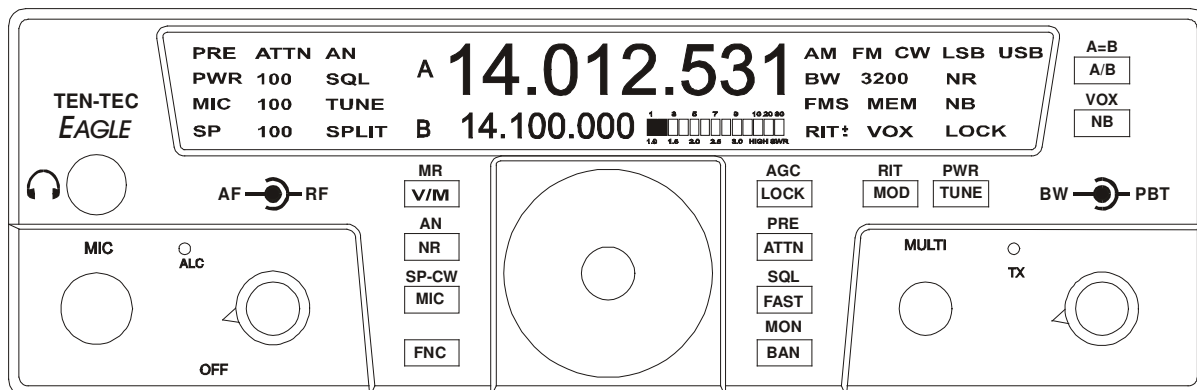

## 1. Your new Eagle 599

### 1.1. Unpacking Eagle 599

Examine the Eagle transceiver for signs of shipping damage. Should any damage be apparent, notify the delivering carrier immediately, stating the full extent of the damage.

Retain all damaged cartons. Liability for the shipping damage rests with the carrier. We recommend that you keep the carton and fillers in the event that storage, moving, or shipment becomes necessary.

### 1.2. About this Manual

A complete description of the features and functions on the Eagle 599 are included within the pages of this manual. The latest version of the Eagle manual is also available to view in pdf format located under the download tab on the Eagle Transceiver via [www.tentec.com](http://www.tentec.com).

You may also find firmware updates plus a full set of schematic diagrams at this same web location.

### 1.3. Accessory package

The additional hardware and accessories listed in Fig 1-1 come standard with your new Eagle.

Look over the items listed and refer to the 5 digit Ten-Tec part number and description should you find the need to replace an accessory. To purchase additional accessories and parts or to report an item missing from this list, please contact Ten-Tec Service (865) 428-0364.

Qty	Part #	Description
1	702	Dynamic Hand Mic
1	27091	Auto Style Fuse, 25 Amp 32V
1	35241	8 PIN DIN Connector
1	35263	Plug – Stereo, 3.5MM (1/8)
1	38040	Allen Wrench, 0.050 Hex
1	41073	Fork Terminal
1	46214	Cable Assembly 4 Ft
1	74020	Warranty card
1	74244	Standard Warranty Sheet
1	74447	Manual for 599
1	74450	How do I become a Ten-Tec Ambassador
1	74454	Eagle Quick Start Guide

Table 1.3-1 Eagle Packing List

## 1.4. Connection to Antenna & Power Supply

The Eagle is designed for use with any antenna system providing a 50 Ohm resistive impedance at the desired operating frequency. Every effort should be made to ensure the impedance of the antenna system is as close as possible to the specified 50-Ohm value. Note that the “G5RV” type antenna and some Windom’s do not provide 50-Ohm impedance on all HF Amateur bands, and an external wide-range antenna coupler or the optional model AT599K Eagle internal auto tuner may be needed with this type antenna. Any antenna to be used with the Eagle must, ultimately, be fed with 50 Ohm coaxial cable.

The Eagle transceiver requires a source of well-filtered and regulated DC voltage. The supply voltage on the Eagle is 13.8 Vdc nominal +/- 15% to allow for mobile and battery operation. The voltage source must be capable of supplying a minimum of 23 amperes continuous duty at full 100 watt output for AM & FM modes. The model 940 or 941 Ten-Tec power supplies will meet or exceed your voltage and current requirements. We recommend using the included DC power cable (P/N 46214). Use of #12 stranded wire is recommended for mobile and in home use to accommodate the required current demand during transmit.

Note: Always enable the power source first and then the transceiver. If a generator or battery connected to a charger is used to supply the DC source, always turn off the transceiver before starting or shutting off the DC source equipment. These recharging devices often generate large voltage spikes that can damage the transceiver.

## 1.5. A word about grounding

A good ground system is essential for optimum operation of any HF transmitter. The best solution is to connect all the station equipment to a single ground connection. Do not make ground connections by connecting one device to another, then that device to another, etc. and then finally to the ground bus. This so called “Daisy-Chain” grounding technique may nullify any attempt at effective radio frequency grounding. See Figure 1.5-1 Grounding

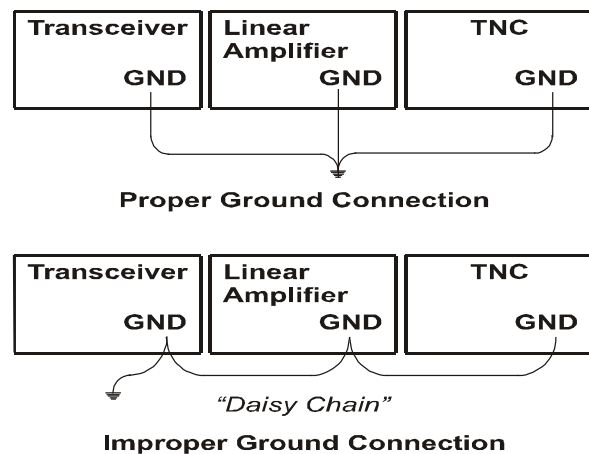

Figure 1.5-1 Grounding

Remember that a connection to a copper cold water pipe is no longer suitable and is in violation of the National Electrical Code. Many modern water connections use plastic pipe, and are not suitable ground connections. A good ground system can contribute to the station efficiency in a number of ways including minimizing the possibility of electrical shock, and minimizing RF currents flowing on the shield of the coax cable causing interference to electronic equipment and transceiver accessories.

## 1.6. Philosophy of design

With the Model 599 Eagle, Ten-Tec has created a transceiver combining simplified controls and ease of operation with the excellent performance of a low first IF 160-through 6-meter ham-band architecture in a compact, mobile-friendly structure. The analog portion of the radio is double conversion with IF frequencies of 9.0015 MHz and 22.5 kHz. A third conversion to zero-frequency IF is accomplished in the DSP processor.

General coverage receive is provided between 0.5 and 30 MHz.

Refer to the Block Diagram in the **Specifications** section for the following discussion. Receive signals are routed through the optional antenna tuner and transmit lowpass filter to a switchable 10dB attenuator at the input of the BPF/Preselector board. This board also contains the bandpass filter selected for the band in use and a switchable 12dB receive preamplifier. On the TX/RX board, output from the preamplifier is mixed with the first Local Oscillator to 9.0015 MHz and routed optionally through the noise blanker to one of three roofing filters. After selectivity roofing, IF amplification is provided by a variable gain amplifier which also develops the high-level AGC. Finally, the 9.0015 IF signal is mixed with the second LO to develop a 22.5 kHz low IF for the Signal Processing Unit (SPU). Based on a 36.096 MHz temperature-stable reference, the Synthesizer board generates first and second LOs via fractional-N synthesis and fixed frequency division. The SPU samples the low IF at 96K samples per second and applies the resulting data to a digital signal processor. Numerical algorithms running in the digital processor accomplish additional selectivity filtering, low-level AGC, and demodulation. The

resulting audio appears at the speaker and line outputs.

The PIC processor in the CPU module executes firmware stored in EEPROM to perform housekeeping functions such as synthesizer programming/tuning, signal switching, and front panel display and control input. Based on the control inputs from the front panel (or remotely via the USB interface), the CPU writes display information, tunes the LOs, adjusts selectivity, and chooses both receiver detection and transmit emission modes. Transmit operation is basically the reverse of receive. Audio or CW signals are generated at zero-frequency (baseband) in the DSP, frequency-shifted to the 22.5 kHz low IF, and output to mixers on the TX/RX board for conversion to the operating frequency. The signal then travels in the reverse direction through the selected Bandpass Filter to the low-level drivers and Power Amplifier, then finally through the Lowpass Filter and optional antenna tuner to the antenna. If the tuner is installed, forward and reverse power measurements from the SWR bridge are used by the CPU to select the correct inductance and capacitance in an L-network to provide a 50 Ohm load to the transmitter output

## 1.7. Configuration Menu

Upon purchase of your transceiver some settings may have already been factory installed and set into the Eagle. Optional accessories such as an auto tuner, a specific additional roofing filter, noise blanker, or your favorite front display color combination will need to be programmed into the Eagle.

To begin configuring the Eagle, start with the Eagle powered off, press the FNC button, and hold the FNC button continuously while powering up the Eagle. When the Eagle is first shipped from the factory, the front panel display will show “F1 2.4” which indicates the factory filter has been installed. Now release the FNC button. To select a different value for a given Configuration Menu item, use the MULTI knob to scroll through the choices. To advance to the next Configuration Menu item, press the FNC button. Once the settings in the Configuration Menu have been set to the desired values, press any key on the front panel except the FNC button to exit the Configuration Menu.

The items contained in the Configuration Menu and their options are shown in the following table.

Item Name	Settings	Notes:
F1	nO / none 15.0/15KHz 6.0 / 6KHz 2.4 /2.4KHz 1.8 /1.8KHz 0.6 / 600Hz 0.3 / 300Hz	Refer to Section “ <b>Optional Filter Installation</b> ” for more information on physical installation of each filter 2.4 KHz is standard, others are optional
F2	Same as F1	Same as F1 Default is nO
F3	Same as F2	Same as F1 Default is nO
EA d	Enable AM detection On / OFF	Requires 6.0 KHz Filter Default is OFF
EF d	Enable FM detection On / OFF	Requires 15.0 KHz Filter Default is OFF
bl i	Backlight Intensity 0..15	Overall intensity of the backlight.
bl r	Backlight red level 0..15	Independent red level adjustment
bl 9	Backlight green level 0..15	Independent green level adjustment
bl b	Backlight blue level 0..15	Independent blue level adjustment
Nb	Noise Blanker Installed OFF On	Refer to section “ <b>Internal Hardware Noise Blanker</b> ”
tu n	Internal Auto Tuner Installed OFF On	Refer to section “ <b>Internal Tuner</b> ”

Table 1.7-1 Configuration Menu Items

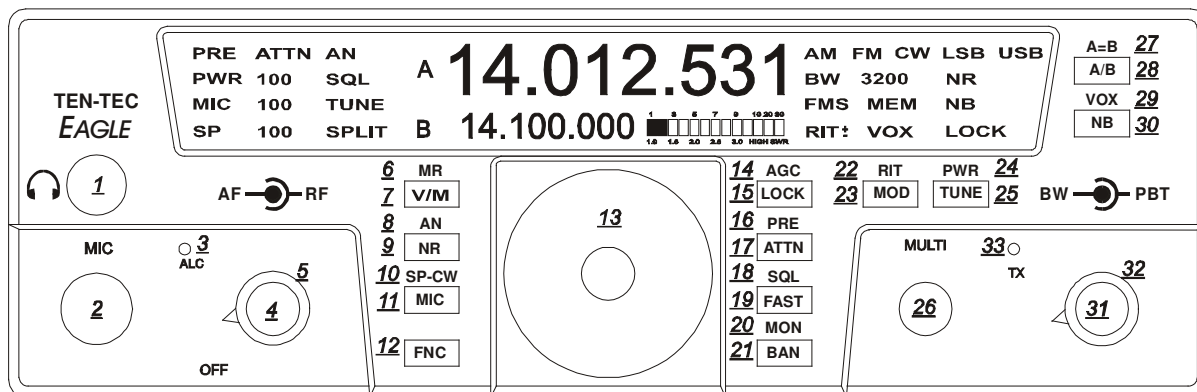

Figure 2.1 Eagle Front Panel

## 2. Easy Operation Guide

### 2.1. General Operations

This section of your Eagle Manual will discuss the button operation and adjustments common to all modes on the Eagle

#### Primary and Secondary Button Functionality

Most buttons on the front panel can perform multiple functions. The Primary Function for the buttons on the Eagle is screened directly on the button. They are lit when power is applied to the radio. The Secondary Function for the buttons is silk-screened above the respective button on the front panel. The FNC button is used to invoke the Secondary Functions of the front panel buttons. The functionality for both Primary and Secondary buttons are described in the following sections.

#### Master Reset (using LOCK (15) button)

To perform a master reset to the Eagle, begin by pressing and holding down the LOCK button at the same time you turn on the power. Continue to hold down the LOCK button until the screen says “reset”.

You have now performed a reset to the Eagle which will also clear all memories and settings you have placed in your transceiver. Performing a reset means you will need to enter the Configuration menu described in Advanced Settings to program your filter positions, accessories, screen colors, etc.

#### Keying a Linear Amplifier:

Pin 8 on ACC-1 will provide an open collector output for keying a linear amplifier. The Eagle provides a 17 ms closure delay before RF is supplied to the linear amp. Refer to Figure 3-2 for wiring to this connector. Remember to use shielded cable for making this connection. The amp key line is not a relay similar to those found on many older transceivers. It is a transistor switch rated for a maximum of 24 volts and 250 mA from the key line of your amplifier. Many older amplifiers using an AC relay or relay voltages exceeding the limits of the Eagle must use an amplifier interface relay such as the ARB-704 sold through the Ten-Tec company P/N #R9901

#### S-Meter

The signal strength display on the Eagle will offer two functions

1. The S-Meter will read the signal strength in receive mode
2. The meter will also function as an SWR meter when transmit tune is activated.

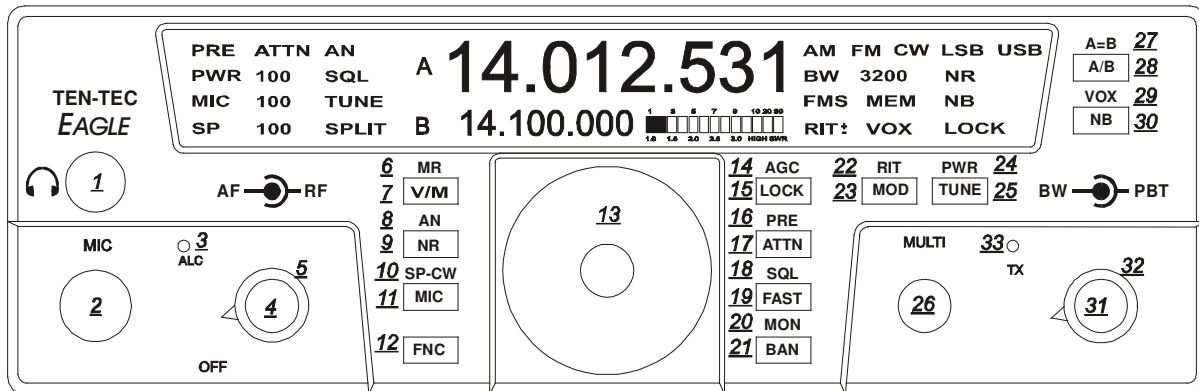

### FNC (12)

The FNC or function button is a vital portion of this radio. All Secondary Functions of the Eagles button set are accomplished by pressing the FNC button. When the FNC button is first pressed, the FNC button will begin flashing. You will also see FUNC blinking on the main screen where the Bandwidth Value is normally displayed. Pressing a button using the Secondary Function will execute that function, either turning it on or off, or changing its mode, etc. Pressing the FNC button once again will exit that secondary feature.

### PWR (24)

Power output will be shown on the Eagle toward the left side of the display. It displays the output in watts and can be adjusted and shown as a numeric value from 5-100. To set the power output simply press the FNC button (a secondary button function) and then press TUNE. The multi knob can now be used to adjust the output. After the power output has been selected you may exit by pressing FNC. The digits appearing on the left of the screen measures the average power so you will notice the digits may flash a smaller value when transmitting in side band mode.

### TUNE (25)

If the auto tuner for the Eagle is not turned on or is not installed this button will generate a carrier signal for tuning purposes at 20 watts. This is providing the power output is set at a minimum of 20 watts. If set lower, it will transmit a lower level carrier. If the power output is set anywhere from 20-100 watts the Eagle will still only tune at 20 watts. This is an easy and safe way to tune an external outboard antenna tuner or solid state amplifier. To increase this power output level while in the tune positions press FNC (a secondary button function) and then press TUNE again. You may now adjust the power level using the MULTI knob to vary the output for tuning a linear amplifier.

If the auto tuner is installed and turned on in the Configuration Menu the TUNE button will now automatically match the Eagle to the antenna you are using. You will hear some clicking noise within the Eagle until the tuner determines the best match. When finished the TX light will flash twice plus you will hear a beep tone from the Eagle. Remember when using an external tuner or when tuning a linear amplifier to always go into the Configuration Menu and turn off the internal auto tuner.

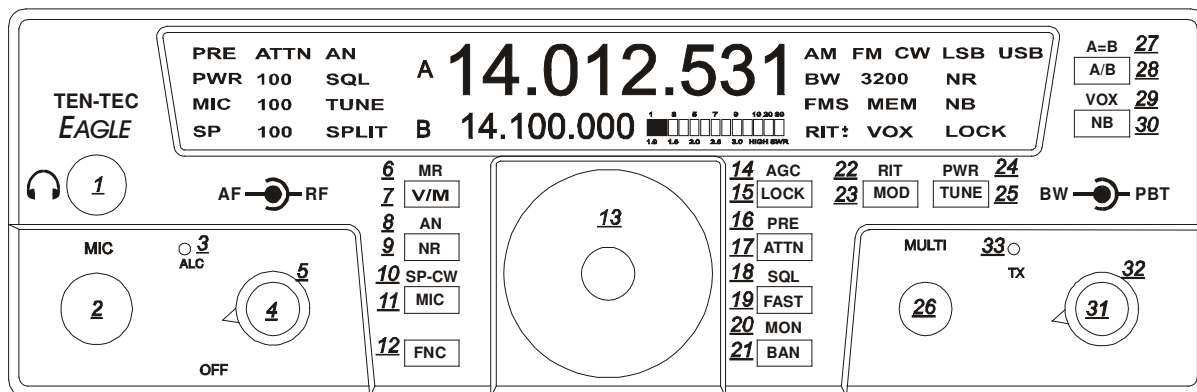

### RIT (22)

The receiver integrated tuning can be selected as a secondary button function by pressing FNC and then the MOD button. You will notice RIT will begin to flash on the front panel and you may now adjust the receiver in 10 Hz increments up or down frequency using the MULTI knob. To zero out the RIT simply press and hold the MOD button and the display will zero out. To exit simply press the FNC button

### Multi (26)

Most features on the Eagle are directly accessible, however, for those that are not the MULTI KNOB is used to adjust specific values. More about this will be addressed within specific features throughout this manual.

### Band (21)

To change bands or toggle through the Ham bands press the BAN button and the next higher Amateur band will appear. To reverse the direction press the function button FNC. It will begin to flash. Next press the BAN button to change directions. Exit the secondary function feature by pressing FNC once again. When the band is changed, the A Frequency, the B Frequency and the Mode are recalled from the last time the band was used. Since the Mode is recalled, the Tuning Rate, and the AGC will also be recalled from the last time that Mode was used.

### Split (28)

To operate SPLIT mode simply press and hold the A/B button for 2 seconds. The word SPLIT will appear next to the B VFO which also indicates the frequency you will be transmitting on. Remember when in SPLIT mode you will always be transmitting on VFO B.

### A/B (28)

This Primary Function allows you to toggle between VFO A and VFO B each time you press the button.

### A=B (27)

The secondary function of this button allows you to copy the contents of VFO A to VFO B. To equal both VFO A and B press FNC button until it begins to flash. Next, press A/B button. Exit Function mode by pressing FNC.

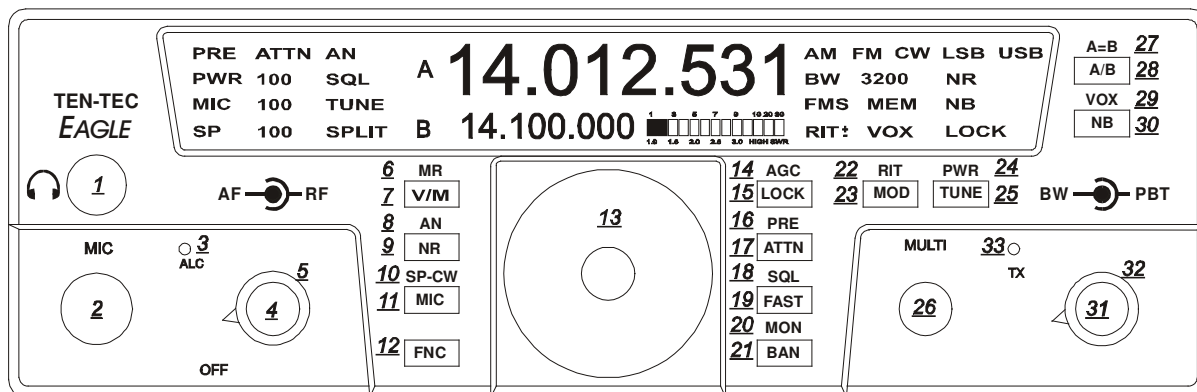

### Lock (15)

To lock the VFO on a frequency so no movement to the VFO knob varies the frequency, press the LOCK button once to lock the VFO. Press the LOCK button a second time to release the lock feature. Lock state is indicated by the text on the right side of your screen when turned on.

### Switching to Memory Operation (7)

Pressing the V/M button activates the memory on the Eagle. Pressing the V/M one time will switch into memory mode. MEM with a number will appear on the front panel screen. Rotating the MULTI knob will address memory locations that hold receive and transmit frequency pairs to control the transceiver. Turning the MULTI control shows the number (1 – 100) for the next available or empty location. At this point, the operator may either (A) copy the information from both VFO's to a memory location; or (B) copy the memory information to the VFO's. To copy the memory channel back into VFO mode simply press FNC (a secondary button function) until FNC and FUNC begin to flash. Next, press V/M button. Exit Function mode by pressing FNC. Your favorite memory can now be tuned and modified with the VFO.

### Storing a Frequency to Memory (6)

When the main display holds a frequency you wish to store into memory, press FNC, (a secondary button function) plus V/M and the MEM front display will show the number of the last used storage location (1-100). You may either accept this location by again pressing the V/M button or change the location by rotating the MULTI knob first. An unused location displays a series of dashed lines --.---.--- on the main display. V/M stores the frequency of the active VFO in the memory (along with current Mode and Bandwidth).

### Recalling a Stored Frequency (7)

You may recall a stored frequency from memory by pressing the V/M button to switch from VFO to Memory operation. With the MEM lit on the screen your current memory location and number will appear on screen. Rotate the MULTI knob until the desired memory frequency appears in the main display, then press FNC (a secondary button function) plus V/M to copy it into the VFO. Exit Function mode by pressing FNC.

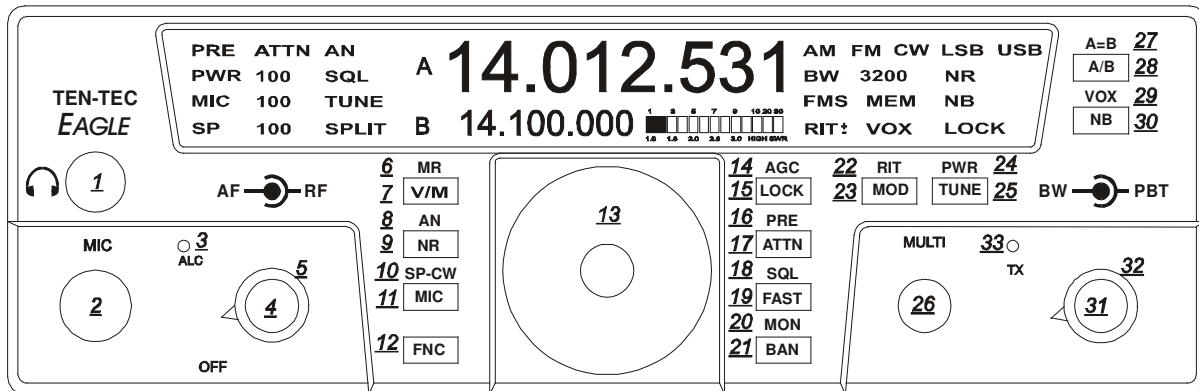

**Headphones: (1)**

Headphones using a ¼” mono or stereo connector can be plugged into the jack #1 located on the front of the Eagle. Headphone Impedance from 8-32 ohms will offer adequate audio levels.

**Mode: (23)**

Pressing the MOD button will toggle the modes to your desired choice. The Eagle will change modes each time the button is pushed. The desired mode is displayed in the top right hand corner of the Eagle screen. The Mode setting utilized in a given band will be recalled when that band is used again.

**Monitor: (20)**

When Eagle is placed in a voice mode you can monitor the transmitted audio signal from the microphone or the line input depending on which one is selected. To toggle the monitor on or off, first place the Eagle in transmit by pressing the microphone PTT button. Next, simply press the FNC button and then press BAN (a secondary button function). You can now adjust the monitor level with the MULTI knob. Please note the monitor will also work in tandem with the AF gain control giving proper audio out of the speaker. Note, there will be no indication of the monitor being turned on or off on the front screen.

**PBT: (32)**

Verify that the PBT control is at the top dead center of rotation to begin listening in all modes.

The PBT control will allow you to move the passband back and forth across the desired signal. It is beneficial in dropping QRM out of one side or the other of the passband or it can simply be used to improve the quality and intelligibility of the signal. An excellent experiment for digital communications is to work the PBT control along with the BW bandwidth control for the greatest selectivity and interfering signal rejection.

**BW: (31)**

Adjusting the BW control will allow you to select the DSP filtering of your choice. Larger numbers increase the band width and smaller numbers will decrease the band width. This control increases the selectivity and removes close in unwanted signals. This control will automatically select the correct roofing filter ahead of the DSP filtering provided a specific roofing filter is installed.

**Fast (19)**

To change Tuning Rate press the FAST button to toggle between 1 Hz, 10 Hz, 100 Hz, 1kHz, 10 kHz Tuning Rates. Each press of this button will step to the next Tuning Rate and you will see this represented on VFO A. Tuning Rate is recalled per mode.

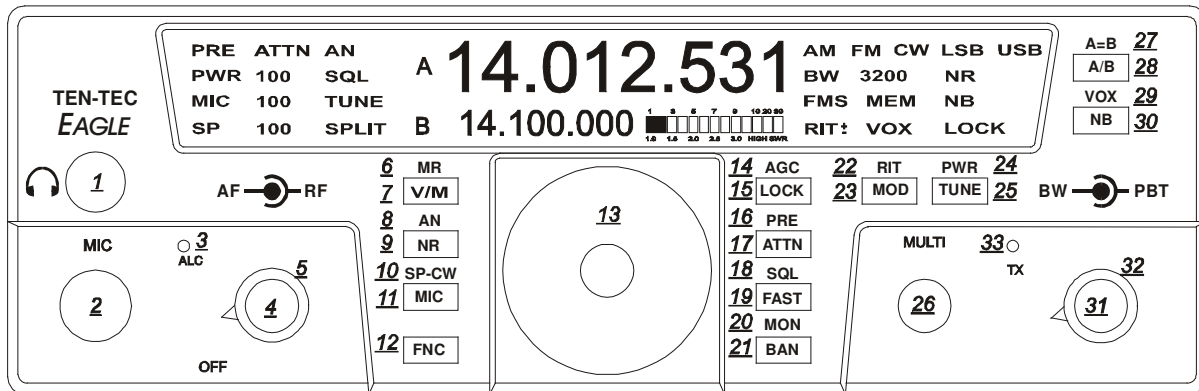

#### AF Gain Control: (4)

Note this is a dual concentric knob. The inside knob controls the audio volume level to the speaker or headphones.

#### RF Gain Control: (5)

The outer ring on this control increases or decreases the receiver IF gain. It is a general rule on the more modern DSP transceivers such as the Eagle to adjust the RF gain fully clockwise and then slowly back down the control (counter clock wise) until you reach a convenient signal to noise ratio. You will discover this control will vary from band to band. As you lower the RF gain it may be necessary to increase the AF gain to get a comfortable listening level.

#### AGC: (14)

Eagle allows for 3 convenient AGC setting **FAST – MEDIUM – SLOW**. For most sideband operation a slow AGC is usually preferred. The letters **F – M or S** will appear on the screen when you toggle to your favorite setting. To change the AGC setting, (a secondary button function)

First press FNC until button and FUNC begin to flash. Next, press the AGC/LOCK button until desired setting appears. Exit by pressing FNC button.

The AGC setting utilized in a given mode will be recalled when that mode is used again.

#### NR: (9)

To activate the DSP noise reduction just press the NR button to turn this feature on and off. When turned on, NR will appear on the front screen. Press and hold NR to bring on screen the settings from 1-10. The multi knob will allow you to adjust the noise reduction value for your comfort level. Press NR again to exit the adjustment mode. The noise reduction system used in the Eagle is a wonderful tool that can assist you in hearing weak signals under noisy band conditions. Under some conditions the NR may affect the quality of a received signal when certain noise and band conditions are present. Often times experimenting with this tool under varied signal strength and band noise such as atmospheric noise will make for a more pleasurable listening experience. Most of the time you will discover that DSP noise reduction will not be necessary especially with strong incoming signals.

#### PRE: (16)

The preamplifier in the Eagle is designed to give you a 12dB increase in signal strength. It is best suited for weak signal reception. To activate the receiver preamp, first press FNC, (a secondary button function) until both button and FUNC begin to flash. Next, press the PRE/ATTN button to activate. Exit by pressing the FNC button.



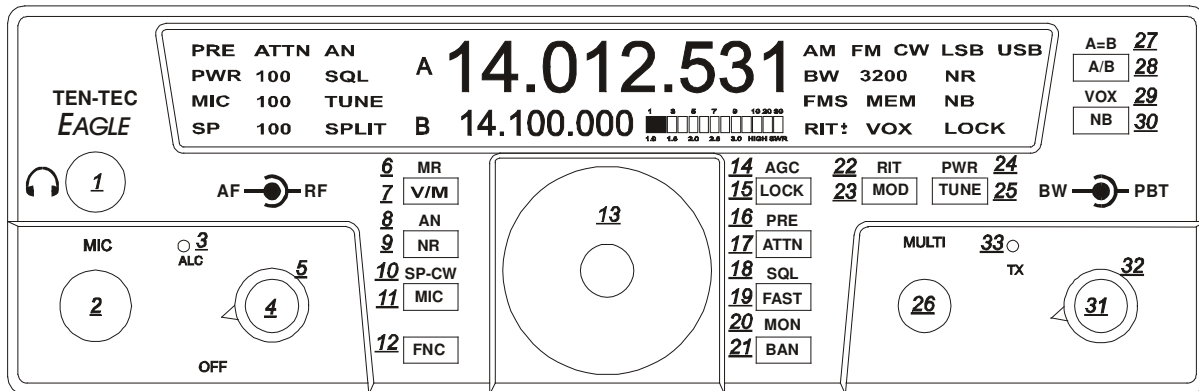

## 2.2. SSB Mode Operation

To begin SSB operation toggle the MOD button to either the LSB or USB for the band of choice you wish to operate.

Note! Remember to set the PBT (32) control to the center of rotation so the side band signal is centered in the desired filter. This results in a starting point for proper side band audio.

### AN: (8)

The AUTOMATIC notch is a useful SSB feature and defaulted to off. This filter implements a special digital algorithm in the DSP system. There is no frequency adjustment for the AUTO-NOTCH feature. This filter will seek out and null all constant carriers in the receiver passband. This notch works well for SSB mode but is not useful in CW. Once AN is activated it may take a second or two for the unwanted carrier to be notched away. Remember some slight audio distortion may exist as this DSP filter is being used to remove an unwanted carrier. To activate AN (a secondary button function) first press FNC until button and FUNC begin to flash. Next, press the NR button to activate. Exit Function mode by pressing FNC button.

The AUTO-NOTCH feature works in LSB, USB, and AM modes. The AN indicator will show the state of the AUTO-NOTCH feature, even in FM and CW modes, but it is not functioning when in FM and CW modes.

### SQL: (18)

This function is designed to operate in either SSB or FM modes. In SSB mode the squelch is activated by first pressing the FNC until button and FUNC begin to flash. Next, press SQL then adjust the squelch level with the MULTI knob for proper levels. Exit Function mode by pressing the FNC button

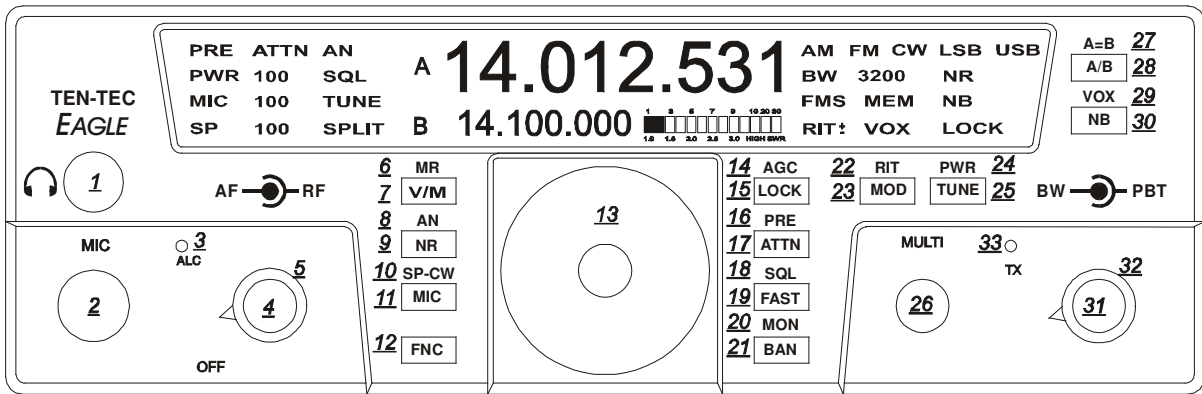

**MIC Connector: (2)**

Front panel jack used for connection of a microphone. The Eagle features the common 8-pin microphone jack used in many amateur radio transceivers. Most dynamic or Electret Microphones can be used. When adapting a microphone, please refer to the wiring diagrams in Figures 2.2-1 and 2.2-2

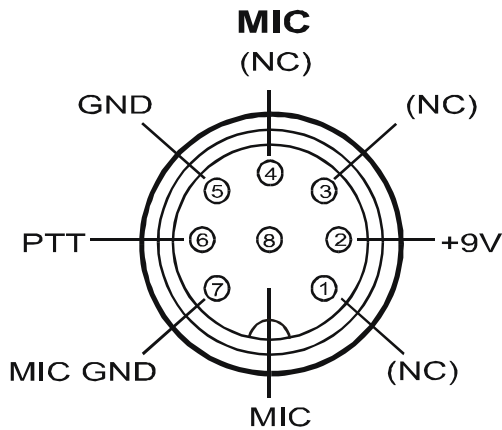

Figure 2.2-1 Transceiver Microphone Jack Front View

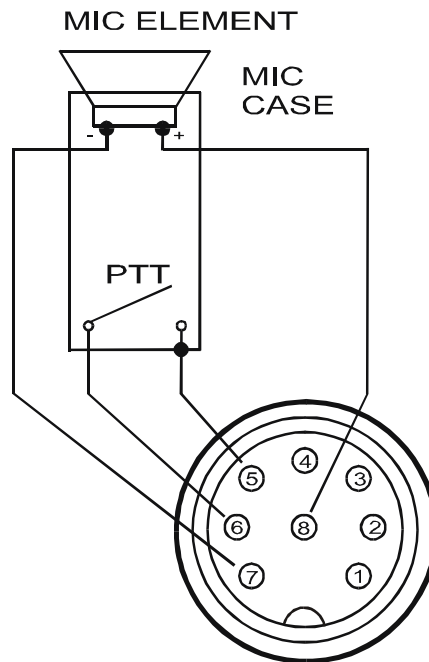
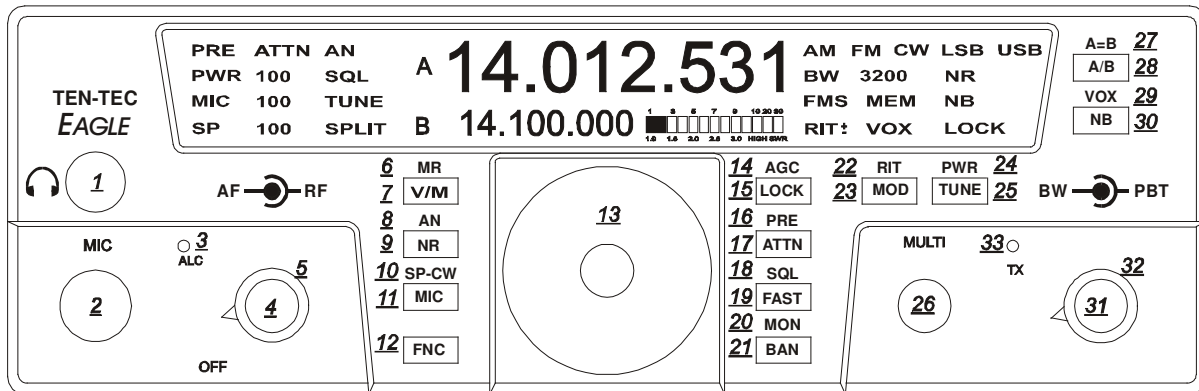

Figure 2.2-2 Transceiver Microphone Jack Recommended Cable Wiring

Pin 2 (+9 Vdc) need only be connected if the microphone element in use is an electret condenser requiring a polarizing voltage.



Chassis ground and mic signal ground are separated to reduce the possibility of introducing stray hum or RFI into transmit audio signal. We recommend that the case of the microphone also be tied to chassis ground on the transceiver via a shielded cable to pin 5. This is to help assure stray RF does not have a path to be coupled into transmit audio.

Cable carrying mic signal and mic signal ground should be shielded. This prevents the cable itself from acting as an antenna and coupling RF back into mic audio. NOTE! Some aftermarket microphones are not wired with separate microphone signal grounds and chassis ground. We recommend separate pins for use for mic negative signal and chassis ground as shown in Figure 2.2-2

**MIC: (11)**

To adjust the microphone gain simply press the MIC button on the Eagle and view the letters MIC on the front display with numbers to the right. At this time key and speak into the microphone to adjust the MIC gain. Use the MULTI knob until the ALC light begins to flash on voice peaks. Your Eagle is now transmitting with proper ALC levels for undistorted SSB operation. Ten-Tec has set the hardware microphone level to accommodate the standard hand microphone.

If other microphones are used with the Eagle, which may need more gain, Ten-Tec has provided a hardware microphone gain control, See Figure 2.2-3. Setting the microphone gain around 35-50 and then adjusting the trim pot on the left side of the transceiver until proper ALC is accomplished will help make the Eagle flexible with a multiple of different style microphones.

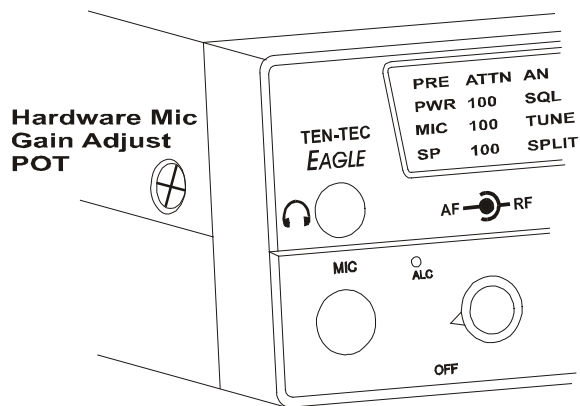
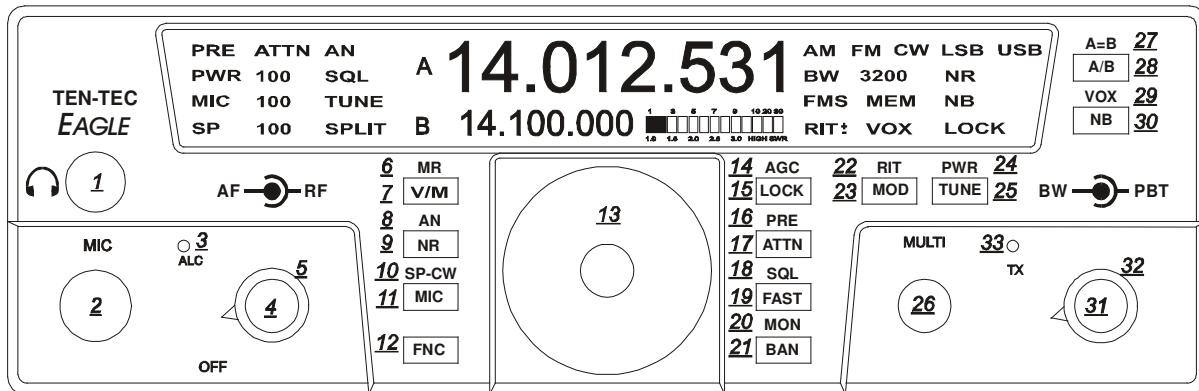

Figure 2.2-3 Hardware Mic Gain Control



### VOX: (29)

To toggle the VOX on and off (a secondary button function) first press FNC until button and FUNC begin to flash. Next, press the NB button and you will see VOX appear on the bottom right side of your screen. Pressing the NB button each time turns the VOX on and off. Exit Function mode by pressing FNC button.

### VOX Settings: (30)

To adjust the VOX gain, Anti VOX and VOX hang (a secondary button function) first press FNC until button and FUNC begin to flash. Next, press and hold for 2 seconds the NB button. This will bring you into the series of VOX settings. These settings will now toggle from one to the other upon pressing the NB button. You can adjust all settings using the MULTI knob. After you are satisfied with your VOX adjustments you may exit the Function mode by pressing the FNC button.

### BW Settings: (31)

Normally below 1800 Hz filtering greatly diminishes the intelligibility of the side band audio. Above 1800 Hz will increase bandwidth for increased audio fidelity.

### PBT Settings: (32)

Rotating the PBT control during heavy QRM plus adjusting the filter Bandwidth setting will greatly reduce close in interference. Some practice may be necessary to determine the most comfortable bandwidth and PBT setting when in crowded band conditions.

### Selecting AUX Audio: (11)

To select from either the microphone input or the rear audio input (5 pin DIN) simply press the MIC button for 3 seconds and the designated MIC will disappear from the front screen. When this happens, the Aux input is now active. To switch back to the microphone input simply press and hold the MIC button again for 3 seconds until MIC appears back on the screen.

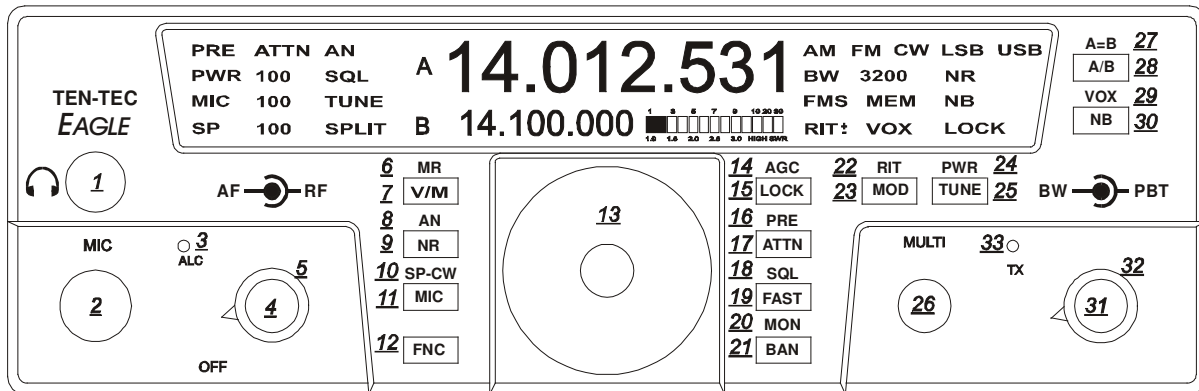

### 2.3. CW Mode Operation

The rear panel on the Eagle has a 1/8" stereo jack for connection of a key paddle. See Figure 2.3-1 for proper wiring.

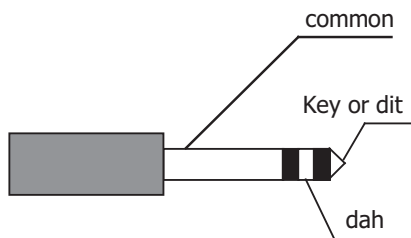

Figure 2.3-1 CW Key Wiring

A straight key, bug, or external keyer can be used with the Eagle. Simply plug a 1/8" mono style connector wired to your device into the rear apron of the Eagle, see Figure 2.3-2. When power is turned on the Eagle will detect that mono device automatically. If you should forget and plug it in after power has been applied simply toggle the mode button once through all modes and back again to CW.

The internal keyer built into the Eagle can be adjusted to select the proper speed, abbreviated (SP xx on bottom left screen corner), weighting, abbreviated (dit SP) center of display, side tone level, abbreviated (stl) center of display, and side tone frequency, abbreviated (stf ) center of display.

To begin adjustments you must first be in the CW mode, next press FNC until button and FUNC begin to flash. Press MIC button to toggle through the keyer functions listed above.

Numerical adjustments are displayed on screen and are made using the MULTI knob. Once you are satisfied you have made the proper adjustments press FNC once again to exit. All adjustments will remain when Eagle is powered off and back on.

#### Note!

Should a MASTER RESET be required the keyer functions will be lost. It is often a good idea to write down your favorite settings so in the event of a reset you can input those settings easily.

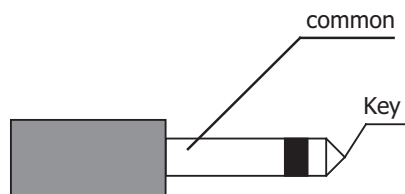

Figure 2.3-2 1/8" Mono Connector Wiring

## 2.4. AM Mode Operation

To operate the Eagle in AM mode you must have the 6 KHz filter installed and you must select EA d in the configuration menu. See table 1.7.1 for a list of the configuration parameters. The peak modulated carrier level will be set automatically for the power level you choose. As an example 100 watts peak to peak will result in 25 watts of un-modulated carrier.

## 2.5. FM Mode Operation

To operate the Eagle in FM mode you must have both installed the 15 KHz filter and you must select EF d in the configuration menu. See table 1.7.1 for a list of the configuration parameters.

## 2.6. Mobile Operation

The Eagle 599 will lend itself to be an excellent 100-watt mobile transceiver. A mobile bracket P/N 321 is available as an optional accessory. Ten-Tec also recommends for convenience the optional 9ft. DC cable with power poles installed P/N 46213. Please refer to the ARRL Handbook for proper mobile wiring and antenna installation techniques.

## 2.7. Digital Mode Operation

For most digital modes of operation you will either be in USB or LSB. To set up the Eagle for digital communications using the Acc rear connector you must first turn on the Acc 1 line input.

Press and hold the MIC button until the word MIC disappears from the front screen and just the gain numbers appear on the screen. You may now adjust the line level gain for the proper levels to your computer or TNC. Pressing the MIC button one more time will toggle the line input off and the microphone input will be turned back on and the display will again show MIC

## 2.8. Internal Hardware Noise Blanker

The Eagle offers an optional model 320 Internal Hardware Noise Blanker. Once the Noise Blanker hardware is installed, go into the Configuration Menu and enable it.

The Noise Blanker can then be turned on and off by using the NB button. The Noise Blanker has two levels of settings. With the Noise Blanker activated, press and hold the NB button for about two seconds. 1 beep will indicate normal setting, and 2 beeps will indicate a more aggressive setting. If 3 beeps are heard, then the Noise Blanker has not been turned on in the Configuration Menu.

CAUTION: If the Noise Blanker is not installed, but it has been turned on in the Configuration Menu, then the Eagle will have no receive audio when NB is pressed.

## 2.9. Internal Tuner

The Eagle offers an optional Internal Tuner. Once the Auto Tuner is installed, you will need to go into the Configuration Menu and enable it on.

The Eagle provides both a manual tune method and an auto tune method.

To change back and forth between manual tune mode, and auto tune mode, press and hold the TUNE button for about 3 seconds, then you will hear a series of beeps. 2 beeps means that you have the Internal Tuner placed in bypass mode, and you can now tune manually. 1 beep means that you have placed the Internal Tuner in Auto Tune mode, and you can use it to automatically find a match internally.

Manual Tune mode is similar to other TenTec radios, press the TUNE button when in Manual Tune mode, and that will place the Eagle into CW Mode, 20 Watts, and then enable the transmitter.

Auto Tune mode is also similar to other TenTec radios, press the TUNE button momentarily when in Auto Tune mode, and it

will start the auto tune process, finding the best match for the given load on the antenna.

## 2.10. Optional Filter Installation

The Eagle has three filter slots: Filter Slot 1 (F1), Filter Slot 2 (F2), Filter Slot 3 (F3). The Eagle comes standard with a 2.4KHz filter installed in Filter Slot 1 (F1). Optional filters are available for the Eagle as follows:

Filter	Part Number
15 KHz	2005
6 KHz	2003
1.8 KHz	2000
600 Hz	2001
300 Hz	2002

Table 2.10-1 Optional Filters

The Filters can be installed in any order into any of the three Filter Slots F1 through F3.

To install new filters:

1. Remove the 4 cover screws, 2 on each side of the Eagle.
2. Carefully raise the top cover.
3. If necessary, unplug speaker cable located on the left side of the main board.
4. Set the top cover aside
5. Locate the Filter Cover Plate, it is identified with F1, F2, F3 as seen below. It has two screws holding it down.
6. Remove the two screws holding the Filter Cover Plate in place.
7. You now see the standard 2.4KHz Filter installed in Filter Slot 1 (F1), and two more filter slots.
8. Locate the location to insert the specific filter into. Refer to Figure 2.10-2. This is according to the Filter Cover, and not the circuit board text. The order is shown on the Filter Cover as F1, F2, F3 going from back of the rig towards the front of the rig. The ground pins are easily distinguished by the way the pins and

outer case connect together. The ground pins will be inserted into the holes for that filter closer to the front of the rig. The text on the top of the filter will then read properly from the rear of the radio. If your filter comes with the vibration barrier attached to the bottom just temporarily remove this cover to verify polarity direction to identify the ground location and re-install vibration barrier.

9. Reinstall Filter Cover with the two screws just removed.
10. If you disconnected the speaker in step 3, then reconnect it now.
11. Reinstall the top/bottom covers with the 4 screws from step 1.
12. Refer to the section on the Configuration Menu on how program the Eagle firmware to use this Filter Setup.

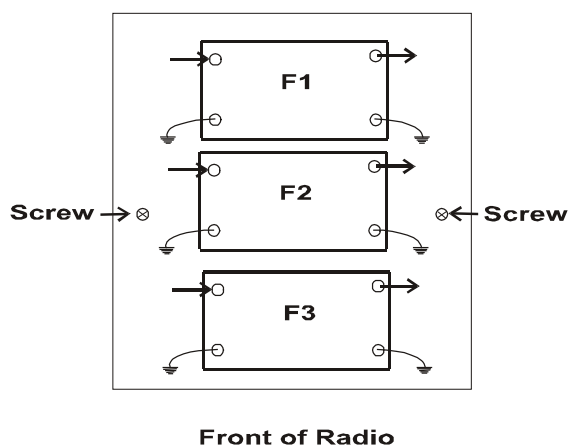

Figure 2.10-2 Filter Location Showing Ground orientation

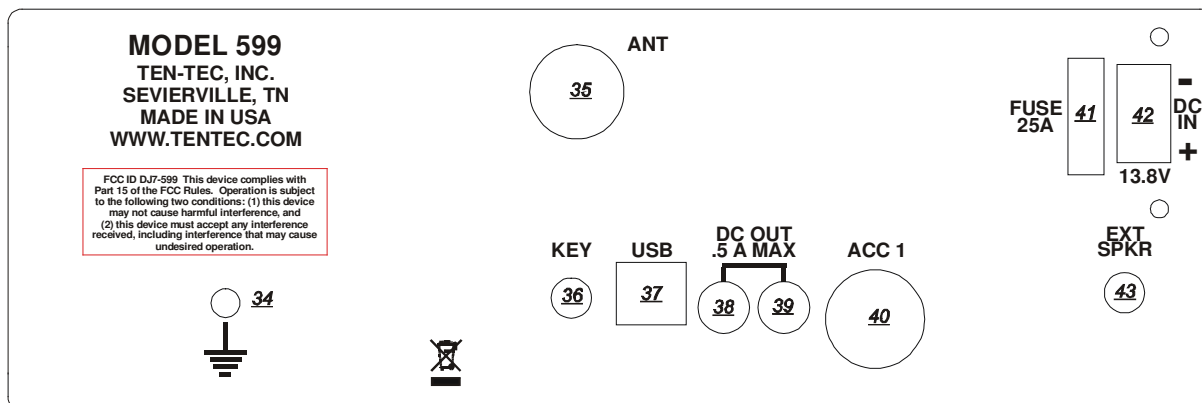

Fig 3-1 Eagle Ear Panel

### 3. Eagle Rear Panel

Figure 3-1 Eagle Rear Panel (Bold/Underlined items are the item # referred to in text)

#### **GROUND TERMINAL (34)**

The wing nut-equipped post is for connection of station ground or counterpoise. See **A WORD ABOUT GROUNDING**, page 3 section 1.5. The ARRL also offers excellent information in the ARRL Handbook concerning station grounding.

#### **ANT (35)**

The ANT connector is an SO-239 jack used for connection of a coaxial fed transceiver antenna, nominal impedance 50 ohms, for use on any band the Eagle covers.

#### **EXT SPKR (43)**

This jack is for connection of an external speaker. When connected using a standard 1/8" phone plug, the internal speaker in Eagle is disabled. Tip of the 1/8" phone plug is audio, sleeve is ground. Requirements for an external speaker connected to Eagle is minimum 4 watts power handling, 4 ohms minimum impedance.

#### **KEY (36)**

The rear panel on the Eagle has a 1/8" stereo jack for connection of a key paddle. See Figure 2.3-1 for proper wiring.

#### **USB (37)**

The rear panel on the Eagle has a Standard B type USB connector. This connector is used for connecting to a PC to perform updates of the firmware, or for logging or control via various available computer programs. Refer to section **Interfacing to a computer and firmware updates** for more information.

#### **DC OUT (38 & 39)**

The Eagle is equipped with two DC output connectors to power various accessories. The output power is limited to 0.5 Amp maximum.

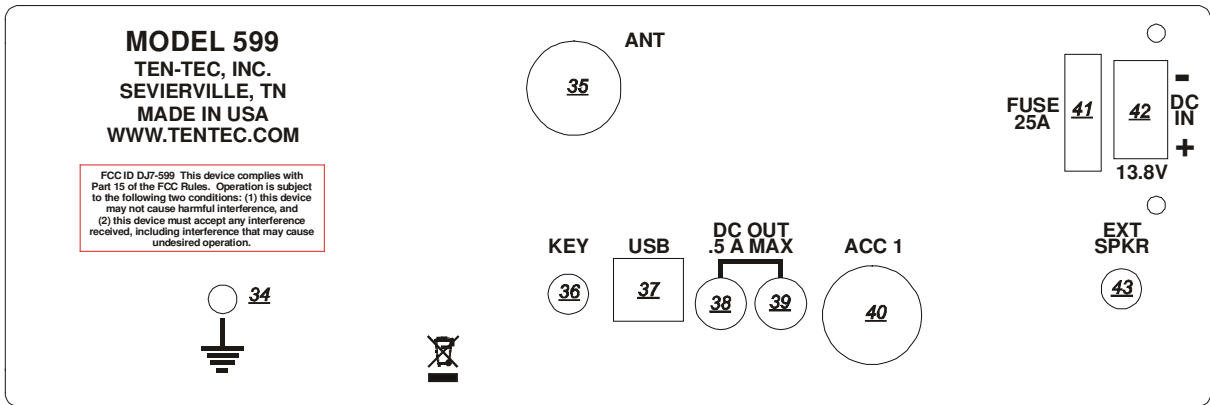

**ACC 1 (40)**

The Eagle is equipped with an 8 pin accessory connector. Refer to following figure for the pin definitions as viewed from the rear panel.

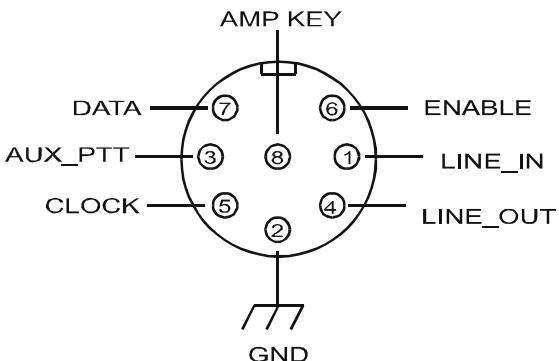

Figure 3-2 ACC1 Pin out

The pin out and function are listed in the following table:

Pin	Name / Direction	Usage
1	Line In / Input	Line level Audio input from an accessory device (like a TNC or sound card for digital mode operation.) Selected using the front panel MIC button.
2	Ground	Grounding
3	Aux PTT / Input	In Voice Modes, when grounded, this pin will key the radio and begin transmitting. In CW Mode, this pin can be used as a keying input for an external device with an external keyer or output of CW sent from a computer.
4	Line Out / Output	Line Level Audio output.
5	Clock / Output	Future Use (Do NOT connect to this pin)
6	Enable / Output	Future Use (Do NOT connect to this pin)
7	Data / Output	Future Use (Do NOT connect to this pin)
8	Amp Key Line	Used to key an external device, such as an Amplifier. Occurs ~15ms before RF is generated.

Table 3-1 ACC1 Pin out

## 4. Accessory Devices

### 4.1. Using the 712 USB/Soundcard Interface

To use the 712 soundcard interface for digital modes, connect the 712 device between the Acc-1 connector and the USB port on your Windows computer. Using your favorite audio generated digital programs can now be used with the Eagle. Audio adjustments may need to be made using the audio equalizer within your Windows software for proper receive and transmit ALC levels.

### 4.2. Interfacing to a computer and firmware updates

The Eagle provides a standard USB 2.0 interface for two purposes:

1. Connection to a PC or other USB Hub device for control or logging or monitoring purposes.
2. Connection to a PC for firmware updates using the standard TenTec upgrade utility.

The physical interface used to connect with the Eagle is a standard USB cable. A standard USB cable will have a type A connector for the computer / Hub and a USB type B connector for the Eagle.

The software interface for the Eagle uses the standard `usbser.sys` driver supplied with windows up through Windows 7. Therefore no special drivers or programs are required to update or communicate with the Eagle other than the standard Update program supplied by TenTec. However, a “.inf” file supplied by Microchip is required to inform Windows how to utilize the standard `usbser.sys` file.

This “.inf” file is available via the TenTec download web page, starting from [www.tentec.com](http://www.tentec.com).

The steps to follow to install the USB driver vary depending upon the version of Windows you are using. Some versions of Windows allow you to “browse” to a driver or .inf file, some don't. If your Windows allows this, then the first set of steps is the best method of installing the driver. If it doesn't, then the second set of steps is the best method of installing the driver.

The steps to install the driver for most Windows versions up through some Windows Vista versions is as follows (Note: depending upon your security settings, you may need to do this using an account with administrator privileges.):

- 1) Download the `cdc_NTXPVista.inf` file from the TenTec web site to your desktop.
- 2) Power on the Eagle.
- 3) Connect the USB cable between the Eagle and the PC.
- 4) When prompted Select "Browse My Computer For Driver Software".
- 5) Select "Let Me Pick From a List of Drivers".
- 6) Select the HAVE DISK button. Then navigate to you desktop and select the `cdc_NTXPVista.inf` file.
- 7) After a few seconds you MAY be presented with a list of several items, including USB to RS232, USB to UART, Select USB to UART.

You should now receive the "Device driver is installed and working properly" dialog and the device will show up in the PORTS list of the Device Manager.

The steps to install the driver for Windows 7 and some Windows Vista installations is as follows (Note: depending upon your security

settings, you may need to do this using an account with administrator privileges.):

- 1) Download the cdc\_NTXPVista.inf file from the TenTec web site to your desktop.
- 2) Power on the Eagle.
- 3) Connect the USB cable between the Eagle and the PC.
- 4) When you notice that Windows 7 has announced it has found a new device, click on the box to watch the progress.
- 5) Once the box shows that no driver was found, close the box.
- 6) Go to Device Manager (in Windows 7, click on Start, Select Control Panel, and Select Device Manager).
- 7) Double Click on other devices to show "SERIAL DEMO".
- 8) Click the right mouse key on "SERIAL DEMO"
- 9) Select Update Driver Software.
- 10) Select the Browse my computer for driver software.
- 11) Select Browse to go to the folder you saved the cdc\_NTXPVista.inf file from step 1 above.
- 12) Click on Next.
- 13) When Windows Security pops up and states "Windows can't verify the publisher of this driver software", select "Install this driver software anyway.
- 14) When Windows comes back with a window that states "Windows has successfully..." showing a "USB to UART", make note of the title bar that shows the com port being used, e.g. "USB to UART (COM6)". You may now click Close, and have installed the driver successfully. You should note that the "SERIAL DEMO" device is no longer visible, but a "USB to UART (COMx)" is now visible in the "Ports (COM & LPT)" section of Device Manager. You may now close Device Manager and Control Panel.

If at any time you need to see what "port" the Eagle is connected to, go back into Device Manager, expand the "Ports (COM & LPT)" selection, and you should see "USB to UART (COMx)". Note the x in the COMx that is reported by Device Manager. You will use this number when running cat programs, the update.exe program, etc.

If required, you can change the actual port number being used to a lower number if required. Sometimes the update program on some computers will require a port number lower than 10. To do so, double click the USB to UART (COMx) text, go to port settings, select advanced, and select a different COM Port Number from the pull down box. It may display a warning message, if it does, confirm/ok the change. Click OK/Confirm/etc. until all windows are closed. Disconnect the Eagle, wait a few seconds, reconnect the Eagle, and you should see the new port number in Device Manager.

NOTE: when you plug the USB cable into a different USB port on the PC, it will most likely get a new COMx port number defined. Be aware of this when reconnecting the USB cable to the computer so that you can set it properly in the computer program that you are using to communicate with the Eagle.

The latest version of the transceiver is always available from our firmware update site.

To upgrade your transceiver, visit the **www.tentec.com** web site and click on “Downloads”, then select “599 Downloads”. A link will be available with the latest firmware version. This link will be titled with the available version number of the firmware. Example: “Firmware Version 1.585”. The Date of the file will also be shown.

Here is the sequence of steps to follow once the .exe file has been downloaded from the Downloads web page for the Eagle/599.

- 1) Turn Transceiver OFF.
- 2) Turn Transceiver ON to verify that the Eagle has appropriate power. E.g. the Eagles front panel display shows the normal indicators and frequencies.
- 3) Turn Transceiver back OFF.
- 4) Connect a PC to the transceiver using a standard USB cable. (Note, if already connected, disconnect for a second or two, then reconnect, helps computers that don't “disconnect” the USB driver unless it is physically disconnected)
- 5) Turn the Transceiver ON while holding down the "A/B" button.

Wait a few seconds. NOTE: There currently is no feedback that the rig is on. Hence the reason for steps 1, 2, 3 above, just to verify that the Eagle has power and is operational.

- 4) Start the Update program
  - 5) Select the COM port to which the Transceiver is attached.
  - 6) Choose UPDATE under the PROCESS menu.
  - 7) Select the RUF file under the Process Menu.
  - 8) The program will update the radio and report any errors encountered.
- During the update process there is no activity on the 599 Eagle to indicate progress.

The only feedback is from the update program to confirm that lines are getting sent/programmed.

- 9) When finished, the 599 Eagle will restart and run the new firmware.

### 4.3. List of Optional Accessories For The Eagle

The Eagle permits the usage of several optional accessories. At the time this manual was printed, the list includes the following items:

Item	Part/Model Number
15 KHz Filter	2005
6 KHz Filter	2003
1.8 KHz Filter	2000
600 Hz Filter	2001
300 Hz Filter	2002
Auto Tuner Kit	AT599K
Noise Blanker Kit	320
Mobile Mounting Bracket	321
9 Ft DC Cable with Power Poles	46213

Table 4.3-1 Optional Accessories

## 5. Specifications

### 5.1. Transceiver Specifications

#### GENERAL

<b>Microphone Connector:</b>	8-Pin
<b>Headphone Jack:</b>	1/4" Mono
<b>External CW Key Jack:</b>	1/8 " Stereo
<b>External Speaker Jack:</b>	1/8" Mono
<b>Aux DC Output Connector:</b>	RCA x2
<b>Frequency Range TX:</b>	Ham Bands Only (160-6M)
<b>ACC Din Connector:</b>	8 PIN DIN Connector - Line In, Line Out, Aux PTT, Ext Key, Clock/Data/Enable, Ground
<b>DC Power Connector:</b>	Power Pole
<b>Fuse:</b>	Automotive Blade Style Fuse, 25 Amp 32V
<b>Frequency Range RX:</b>	500 kHz – 30 MHz and 50 – 54MHz. Specifications apply within Amateur Radio bands only.
<b>Tuning Step Size:</b>	1, 10, 100, 1000, 10000
<b>Frequency Stability:</b>	Maximum +/- 0.5 PPM over operating temperature
<b>Antenna Impedance:</b>	50 ohms nominal.
<b>Antenna Connectors:</b>	1 x SO-239 transceive
<b>Modes:</b>	USB, LSB, CW, AM (optional), FM (optional)
<b>Memories:</b>	100
<b>Frequency Accuracy:</b>	±5Hz @25°C, 1 Hz tuning resolution
<b>Supply Voltage Range:</b>	13.8V +/-15%
<b>Operating Temp. Range:</b>	0-50 degrees Celsius
<b>Dimensions (HxWxD):</b>	2.9" x 8.5" x 10.25" (excluding knobs and connectors)
<b>Weight:</b>	7.25 lbs with all options
<b>Construction:</b>	Molded plastic front panel, aluminum chassis and texture painted steel covers
<b>PC Control Port:</b>	USB (using FTDI USB to UART Driver)
<b>Display:</b>	Custom FSTN monochrome LCD
<b>Display Backlight:</b>	256 colors X 16 intensity levels

## **RECEIVER**

<b>SSB Sensitivity:</b>	0.5uV, 2.4kHz, 10dB SINAD, preamp off
<b>AM Sensitivity:</b>	1.3uV, 30% Mod, 6kHz BW, 10dB SINAD, preamp off
<b>FM Sensitivity:</b>	2.2uV, 5kHz Dev, 16kHz BW, 10dB SINAD, preamp off
<b>Selectivity IF1:</b>	2.4kHz standard, 9.0015 MHz, 2 options
<b>Selectivity IF2:</b>	30 KHz Lowpass filter
<b>Selectivity, DSP IF:</b>	127 built-in DSP filters from 100-15000 Hz BW.
<b>IP3 (Third Order Intercept Point):</b>	21.5dBm/20kHz tone separation, 19.5dBm/2kHz, preamp off
<b>IMD3 Dynamic Range:</b>	100dB/20kHz, 99dB/2kHz, 300Hz BW, preamp off
<b>Blocking Dynamic Range:</b>	141dB/20kHz, 130dB/2kHz, 500 Hz BW, preamp off
<b>LO Phase Noise:</b>	-132dBc/Hz@20kHz, -121dBc/Hz@2kHz
<b>Noise Floor:</b>	-137dBm/300Hz BW, preamp on
<b>Image Rejection:</b>	1st IF: >90dB/HF bands,>70dB/6M
<b>2nd IF:</b>	>73dB
<b>IF Frequencies:</b>	1st:9.0015 MHz, 2nd:22.5 kHz, 3rd:0Hz (DSP)
<b>IF Rejection:</b>	>70dB
<b>Other Spurious Response Rejection</b>	Rejection: >80dB; Birdies: <-100dBm equivalent*
<b>Pass Band Tuning:</b>	+/- 2.1kHz, 5Hz steps. Small dead zone for centering
<b>Attenuator:</b>	10 db
<b>PreAmp:</b>	12 db
<b>Audio Output:</b>	2W into 4 ohms, <3% THD
<b>RIT range:</b>	+/- 8.2 kHz
<b>RIT Step size:</b>	10Hz
<b>S-Meter Reference:</b>	S9 = 50 uV RMS
<b>TX&gt;RX Recovery Time:</b>	< 20 ms
<b>RX Headphone Output:</b>	Designed for 16-32 ohms impedance headphones. Usable at 8 ohms
<b>AUX Audio Output:</b>	500 mv
<b>Auto Notch:</b>	IF DSP, multi-tone
<b>RX Noise Reduction:</b>	IF DSP, adjustable
<b>Noise Blanker:</b>	Optional HW, 2 levels of blanking
<b>RX Current Drain:</b>	1.25 Amps
<b># of IF DSP Filters:</b>	127 built-in DSP filters from 100-15000 Hz BW.
<b>General Coverage Receive:</b>	degraded specs outside ham bands

## TRANSMITTER

<b>RF Power Output:</b>	Adjustable, 5-100 W, +/- 1 dB
<b>CW &amp; SSB Duty Cycle:</b>	continuous service @ 100W
<b>AM,FM,AFSK,PSK Duty Cycle:</b>	continuous service @100W, 50% duty cycle (Tx/Rx)
<b>AM TX Bandwidth:</b>	6k
<b>Microphone Input Impedance:</b>	>10 k-ohms at 1 kHz
<b>Microphone Sensitivity:</b>	1 mV RMS for full power output, internal gain adjustment, 9v dc power for electret elements
<b>FM Deviation:</b>	+/- 5 kHz peak nominal
<b>AUX Level Input:</b>	variable, 200mV nominal
<b>SSB Carrier Supression:</b>	> 70 dB
<b>Unwanted Sideband Suppression:</b>	> 60 dB at 1 kHz
<b>Harmonic &amp; Spurious Outputs:</b>	<-50dBc @100 W <30MHz; -60dB >30MHz; -43 dB <5 W
<b>T/R Switching:</b>	PTT or VOX on SSB, AM, FM, QSK on CW
<b>CW Keyer Type:</b>	Internal Curtis Mode B
<b>CW Rise and Fall Times:</b>	5ms
<b>CW Offset:</b>	adjustable
<b>CW Keyer Speed:</b>	5-60 WPM, adjustable weighting
<b>Current Drain:</b>	transmit 20 amps typ.
<b>Third Order Intermod:</b>	Better than 25dB below peak
<b>SSB Generation:</b>	DSP Generated
<b># of DSP generated TX bandwidths:</b>	3 built-in DSP filters - automatically selected based on mode – for CW/SSB = 2.4Khz; for optional AM = 6Khz; for optional FM = 12KHz  (Note, this also means that the 6KHz filter is required for AM transmit, and the 15KHz filter is required for FM transmit, otherwise transmit is not permitted)

## ANTENNA TUNER

<b>Type:</b>	Reversible L-network
<b>Matching frequency range:</b>	160 to 10 Meters, no Six Meters
<b>Matching impedance range:</b>	10:1 SWR typical

## OPTIONS

<b>4 Pole Roofing Filters:</b>	2.4K standard, optional = 300, 600, 1.8k, 6k, 15k
<b>Noise Blanker:</b>	daughter board module



## FCC Compliance

Note: This equipment has been tested and found to comply with the limits for a Class B digital device, pursuant to part 15 of the FCC Rules. These limits are designed to provide reasonable protection against harmful interference in a residential installation. This equipment generates, uses and can radiate radio frequency energy and, if not installed and used in accordance with the instructions, may cause harmful interference to radio communications. However, there is no guarantee that interference will not occur in a particular installation. If this equipment does cause harmful interference to radio or television reception, which can be determined by turning the equipment off and on, the user is encouraged to try to correct the interference by one or more of the following measures:

- Reorient or relocate the receiving antenna.
- Increase the separation between the equipment and receiver.
- Connect the equipment into an outlet on a circuit different from that to which the receiver is connected.
- Consult Ten-Tec service for technical assistance (865) 428-0364

## 6. In Case of Difficulty

While we cannot cover every possible problem, here are some hints for dealing with some potential difficulties. Check the obvious. Is your dc power source okay? Check power supply, cable and connector(s). Is the 25 ampere fuse loose or missing? Antenna problems? Try a dummy load. Is a proper antenna connected? Is any external antenna switch connected and properly set? Have you double-checked the Eagle's many control settings, including those in the Configuration menu, for your intended mode of operation? Have you checked how the optional Filter's are installed and confirmed their installation ordering versus the Configuration Menu?

### **Problem: No audio from receiver**

Is the AUDIO (AF) turned up?

Is RF GAIN turned down (receiver will mute, and S-meter will read a higher value than band noise).

Is squelch activated? SQL will appear in block letters on the screen. Press FNC then FAST/SQL and check SQUELCH level.

Is the speaker wire internal to the rig broken or disconnected? (Have you pulled the covers off recently?) Try headphones to see if audio returns.

Is NR off? Under some circumstances, noise reduction can cover band noise completely, leading the user to think no audio is coming from the speaker.

### **Problem: Distorted SSB transmit**

Be certain the mic gain is set properly. The ALC LED should flash on voice peaks, but not remain continuously lit in SSB modes.

Check the setting of the speech processor. An excessively high setting can reduce audio quality.

A frequent cause of a distorted SSB signal is inadequate RF grounding resulting in RF feedback. Common RF grounding problems

are no ground connection, or too long a lead to a good ground. Many problems relate to the lack of an RF station ground, as contrasted with a safety ground connection. We recommend bonding all equipment chassis together with short heavy metal braid or strap. Make these connections from chassis ground lug to chassis ground lug and connect the last piece in the chain feeding the antenna to a good earth ground. This lead needs to be as short as possible. Lengths near  $\frac{1}{4}$  wavelength on any band used can be particularly troublesome when the far end is connected to earth.

Another potential cause of distorted SSB arises when the station is in the near field of the antenna. This is a problem many apartment dwellers face.

Distorted SSB transmit can result from chassis ground and signal ground from the microphone being tied together to a common connection. This is a common problem with third-party microphones. Assure the chassis ground and signal ground from the microphone is separated.

### **Problem: Transceiver power shuts off while transmitting**

The Eagle is equipped with a silicon-controlled rectifier that opens if the PA current draw exceeds an instantaneous power of approximately 30 amps. This will shut off power to the transceiver. Excessive current draw can indicate a problem with excessive SWR due to antenna or feedline problems. Power to the radio can be restored by cycling the power switch and off or the 13.8 Vdc source on and off.

**Problem: No transmit, receive OK.**

Are you trying to transmit outside of the Ham Band?

Is the gain setting correct for the microphone input or ACC 1 jack as appropriate?

Is the POWER control turned all the way down? Press PWR and check.

If no transmit in digital modes, are you sure a PTT signal is being sent from your TNC or computer to the appropriate jack on the Eagle?

Are the internal fans running at maximum? If so, then this could indicate the Eagle has a final amplifier temperature of 70 degrees C or higher. In this condition, the radio will stop transmitting for until the final amplifier temperature is back down to a reasonable level.

**Problem: Get a “PORT in use” when trying to run my favorite logging or computer control program or when trying to update the firmware.**

Have you confirmed the proper port number in Device Manager? Remember that when connecting the USB cable to the USB port on the computer, every time you connect the USB cable into a different USB port on the computer, it will have a different COM port number. You can verify this in Device Manager. It is possible that the USB port was used previously and for some reason Windows has not released it for use. In this instance, disconnect the USB cable at either the computer end or the Eagle end, exit the program you are trying to use, wait a few seconds, then reinstall the cable and then restart the program you were trying to use.

If the above do not solve your problem, please consult with our service department (865) 428-0364 or [service@tentec.com](mailto:service@tentec.com)

## 7. Warranty & Return Policy

Warranty policy for Ten-Tec products is covered in the gold color page located on the last page of this manual.

**FOR EQUIPMENT MANUFACTURED BY TEN-TEC:** Ten-Tec factory built radio equipment is sold under a 30 day risk-free trial period. Any piece of equipment manufactured by Ten-Tec may be returned, undamaged, within 30 days of purchase for a full purchase price refund, less shipping charges (customer pays shipping both ways).

If you want to return a piece of equipment purchased from Ten-Tec, please call the sales department at (865) 453-7172 from 8 a.m. to 5 p.m. Eastern time, Mon-Fri and obtain a return merchandise authorization number. Calling in advance for an RMA number allows us to quickly process your return and refund once your item arrives. Ship return items with letter enclosed inside the box noting the RMA number and your name, address, and telephone number. Return items are shipped to Ten-Tec., 1185 Dolly Parton Pkwy, Sevierville, TN 37862 USA.

## 8. Revision History

Date	Version	Section	Item
September 22, 2010	1.001	All	Initial Production Release Version
September 27, 2010	1.002	8.0 Revision History	Added Revision History
		5.1 Transceiver Specifications	Modified Frequency Range RX to actual.